

VIC TOKAI™  
NES-G3-USA

# TOP SECRET EPISODE

**ONLY YOU CAN HELP HIM  
SAVE THE WORLD!**

**GOLGO 13™**



Thank you for selecting the fun-filled "GOLGO-13" game pak by VIC TOKAI, INC.

## SAFETY PRECAUTIONS

Please take time to read the important instructions in this booklet. Observing the step by step instructions and complying with warnings will be your personal guarantee to greater game satisfaction over a long period of time.

- 1) Avoid subjecting this high precision game pak to extreme temperature variances and tremendous shock. Furthermore, never attempt to disassemble your game pak.
  - 2) Do avoid touching terminal connectors, and keep clean by inserting game pak in protective STORAGE case.
  - 3) Use of thinners, solvents, benzene, alcohol and other cleaning agents can damage the game pak.
  - 4) For best results, play the game a distance away from your television set.
  - 5) Pause for 10-15 minutes after 2 hours of more of continuous game playing. This will extend the performance of your game pak.
- \* Please note that this game has been programmed to take advantage of the full screen. Some older models have rounded screens and may block out a portion of the image.

THIS GAME IS  
LICENSED BY NINTENDO  
FOR PLAY ON THE  
  
**ENTERTAINMENT  
SYSTEM®**



NINTENDO® AND **Nintendo ENTERTAINMENT SYSTEM®**  
ARE TRADEMARKS OF NINTENDO OF AMERICA INC.

# TABLE OF CONTENTS

1. How to play .....	p.4
2. Story .....	p.5
3. Cast of characters .....	p.7
4. Scene description .....	p.8
5. How to operate the controller .....	p.10
6. Enemies .....	p.11
7. Paraphernalia .....	p.13
8. The way to secret conquest .....	p.14
9. Maps.....	p.16

# 1. How to play

Action progresses horizontally on the screen. During play, if suddenly attacked from a blind angle, the scene will change to what is called pan and zoom. In this case the player will see the scene from GOLGO-13's perspective. When all enemies have been wiped out, action resumes at the beginning of the scene.

On the horizontally scrolling screen, there will be a subway and a building. There you meet a person who gives you information that will help unravel the story (in the animated text window).

In the action maze, when enemies are being knocked off and falling against the walls, you can search for various paraphernalia (see part 7). Even with these paraphernalia, you must pass through the laser curtain at precisely the right time or you will be killed.

When you have used up all your bullets, take appropriate precautions. As you knock off your enemies, LIFE credits and your supply of BULLETS are restored.

The total number of "telecasts" is 52. (\*You may CONTINUE to 51) When, in the middle of play, you go pass 52 times you will have to return to the very beginning of the game ; so be carefully.



## 2. Story



High above New York City a helicopter explodes. Aboard the craft is the latest bacteriological warfare weapon secretly developed by the CIA (Central Intelligence Agency)..... Cassandra-G. A vaccine and plans have been stolen from among the fragments of the helicopter wreckage. A shell fired from an M-16 has been discovered.

The copter was shot down from fire from an expert sharpshooter armed with an M-16 carbine..... The CIA concludes that the act was the responsibility of the super sniper, Golgo-13. An official release by the CIA links Golgo-13 to the KGB (the Soviet intelligence group).

Under these circumstances, The CIA Copter Incident, and the whereabouts of Cassandra-G become entangled. A representative of a secret international organization called FIXER transmits a message. FIXER believes the affair is the work of the remnants of the DREK Empire and not Golgo-

13. After the dispatch, the representative disappears.

The situation becomes more and more mysterious. A man who calls himself Condor agrees to help FIXER.

In East Berlin because Condor has received some information on Cassandra-G, the CIA, KGB, and even DREK are threats to his life.

On request from FIXER Golgo-13 has gone into action. He is to get information on a vaccine from Condor and eliminate the leader of the DREK group.

But wouldn't you know it? Just who is this ultimate target of Golgo-13? Just where is this Condor? And just who is the real culprit behind the CIA helicopter explosion?

Many enemies await you..... Now that you have become Golgo-13, let's go to East Berlin.

### 3. Cast of characters



#### ● Duke Togo (Golgo-13)

Uses a custom-made M-16 regularly, a sharpshooter with 100% accuracy, the ultimate sniper. We do not have many

details on him. Dragged into the scene when a CIA chopper explodes and goes down, he now undertakes to solve the whole mess as requested.



#### ● Condor

Because he has acquired information on Cassandra-G, the CIA, KGB, and DREK are after him.



#### ● Cherry Grace

Dispatched from FIXER, she is assigned to assist Golgo-13.



#### ● Oz Windham

He is a FIXER investigator whose whereabouts are currently unknown. He is being held prisoner in the underground base of the DREK group somewhere in East Berlin.

## 4. Scene description

### Animated Text Window



- At the end of the dialog, pressing the A-button will repeat the text on occasion.
- Should you not follow the clues in the text or fail to follow the story line, you will no longer get anyone to appear in the animated text window.

### Horizontal Action

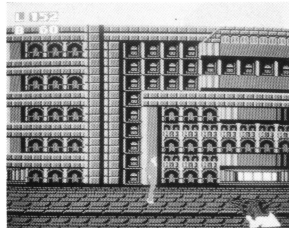

- L...Player LIFE (MAX. 200)
- B...Remaining ammunition (MAX. 400)
- When selecting CONTINUE, you get half the remaining ammunition.
- When you slip below 50 LIFE credits, a warning sound will be given.

## Pan & Zoom

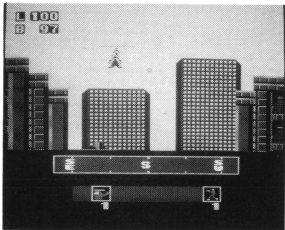

Enemy type/No. (\*If the enemy is completely wiped out, the indicator will go out.)

When a single enemy aircraft approaches, an arrow will show its course.

## Action pass Maze

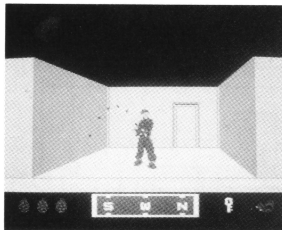

hand grenade indicator  
paraphernalia indicator

To keep playing you must destroy your enemies and the wall.

# 5. How to operate the controller

This game is only a (1) player game.

## ● Controller parts

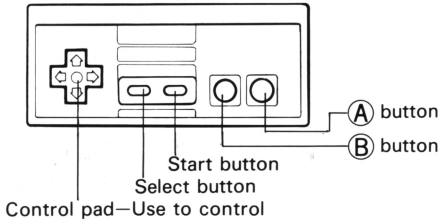

Control pad—Use to control

## ● Horizontal action

A ; Fire gun

B ; Jump

+ : Move, front & rt/lft

## ● Animated Text window

A ; Turn GOLGO-13's face  
Turn page next dialog

B ; Push (B) at end of dialog

+ ; Not used

## ● Maze

A ; Display sight  
Use gun

B ; Not used

+ ; Move, front/back &  
rt/lft

## 6. Enemies

### <Action on the Ground>

- |                       |                     |   |
|-----------------------|---------------------|---|
| [ Information peddler | ● a passerby        | Cannot attack. Occasionally useful information.                     |
| [ Sniper              |                     | Some may attack suddenly, so be cautious.                           |
| [ Kicking woman       | ● Elsa              | Uses both a gun and a karate kick. Can attack only twice.           |
| [ Motorcycle          | ● Willy             | Runs around recklessly with the front tire raised above the ground. |
| [ Fire                | ● "Stinger" soldier | Hurls fireballs from his bazooka. Can attack 6 times.               |
| [ Mine field          |                     | If touched, your LIFE credits will decrease.                        |
| [ Hovercraft soldier  |                     | Watch out for his boomerang. Can attack 4 times.                    |
| [ Laser artillery     |                     | Is fired irregularly. Can attack 4 times.                           |

## <Air Battle>

- [ Harrier A dive bomber
- [ Bomber Attacks from the rear scattering shells all about.
  
- [ Rolling Thunder A mysterious revolving object. Can attack 15 times.
- [ Submarine Launches missiles which cannot fail.

## <Action on Water>

- [ Sharks Appear in front of you.
- [ Octopus You must attack this thing again and again to kill it.
  
- [ Underwater missile Is launched suddenly from the rear.
- [ Frogmen corps They appear from the rear firing underwater spearguns
- [ Mines Making contact causes damage. They cannot be destroyed.
- [ Marine plants Making contact causes damage. Shooting them 5 times kills them.

\* Besides these, various other adversaries may appear. Some can be killed with a single shot, others not. If you knock off a strong adversary, your LiFE credits and amount of ammunition increase dramatically.



# 7. Paraphernalia



## Hand grenade

Destroys closing walls. Picked up from soldiers armed with machine guns and bayonets.

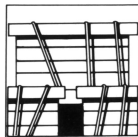

## Ammunition

There are 400 bullets stored here. When taken, your supply is full.

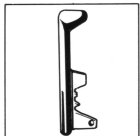

## Key

Is used when a door is locked.



## Nutrition Drink

LIFE credits reach their maximum.

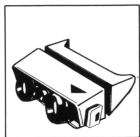

## Infra-red binoculars

Used to detect laser beams that would otherwise not be seen. Even if you have the binoculars, it is not certain that you can dodge laser fire; but not having them could prove fatal.

## 8. The way to secret conquest

- Anyway, you have to knock off the enemy. When ammunition is low, on the horizontally scrolling screen use the (B) and (A) button jump kick.

In pan and zoom mode, before the enemy missiles are attacked, you shoot these missiles. (You must not fail to destroy these enemy missiles)

Also, both going to a hotel and picking up paraphernalia occasionally increase your LIFE credits. You might study in actual battle conditions just how much damage you absorb under an enemy attack and just how much you gain when you eliminate an enemy.

- If you make progress on your jump kick, you will find that you can employ a number of different useful techniques. Think about this.
- Keep in mind that before entering the action maze you should make sure that you are carrying 3 hand grenades. If you knock off a soldier with a machine gun, you will get a hand grenade.
- Listen very carefully to the dialog that is spoken in the animated

text window. A lot of information is given in dialogs that can only be heard once, so watch for it.

- If you get stuck, go back to a place that you have been to before.
- In the action maze, if you become confused, try preparing a map for yourself on graph paper. In a fight, all you need are effort and spirit to win.

# 9. Maps

- A map to an Underground Base Beneath Berlin

First level down

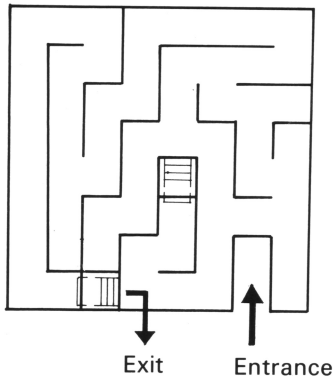

Second level down

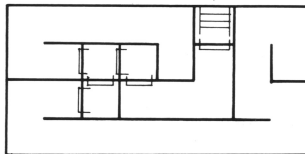

● A Map to an Underground Fake Base Beneath Berlin

First level down

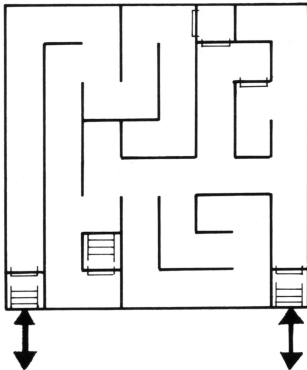

Exist/Entrance

Second level down

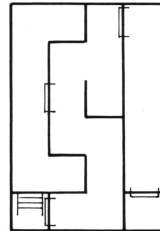

## ● A Map to an Underground Base Beneath Greece

First level down

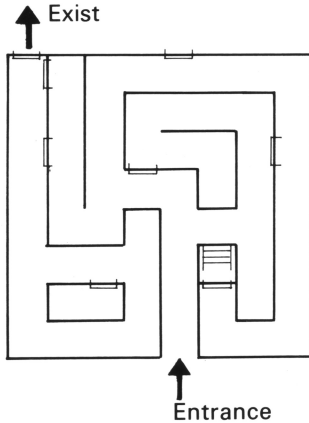

Second level down

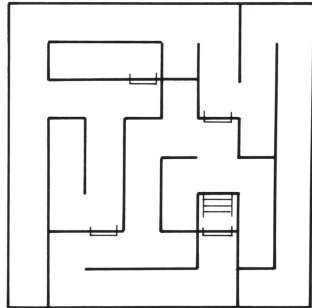

● **A Pass of an Underground Base Beneath Fangbacks Bldg.**

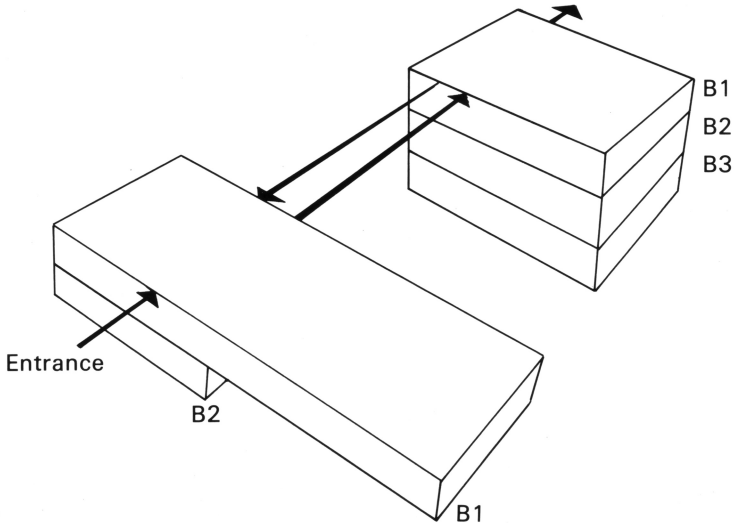

● A Map to an Underground Base Beneath Fangbacks Bldg.

**B1**  
(Light Blue)

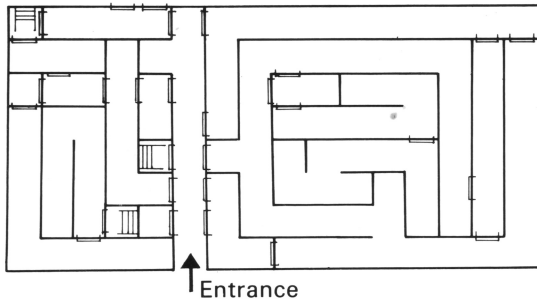

**B2**  
(Dark Blue)

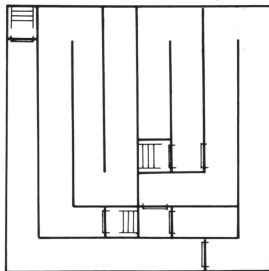



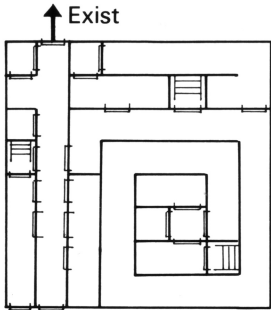

**B1**  
(Purple)

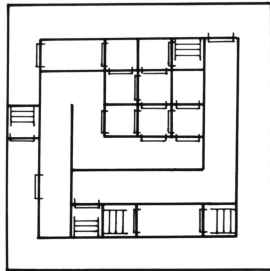

**B2**  
(Pink)

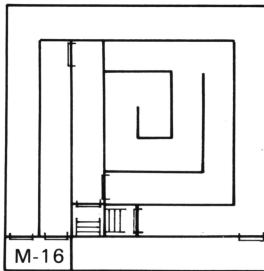

**B3**  
(Scarlet)

## **90-DAY LIMITED WARRANTY**

VIC TOKAI INC. warrants to the original purchaser only that the cartridge provided with this manual and the software program coded on it will perform in accordance with the descriptions in this manual when used with the specified equipment, for a period of 90 days from the date of purchase. If the program is found defective within 90 days of purchase, it will be replaced. Simply return the cartridge to VIC TOKAI INC. along with a dated proof of purchase. Replacement of the cartridge, free of charge to the original purchaser (except for the cost of returning the cartridge) is the full extent of our liability.

THIS WARRANTY IS IN LIEU OF ALL OTHER WARRANTIES, WHETHER ORAL OR WRITTEN, EXPRESS OR IMPLIED. ALL IMPLIED WARRANTIES, INCLUDING THOSE OF MERCHANTABILITY AND FITNESS FOR A PARTICULAR PURPOSE, IF APPLICABLE, ARE LIMITED IN DURATION TO 90 DAYS FROM THE DATE OF PURCHASE OF THIS PRODUCT.

VIC TOKAI INC. shall not be liable for incidental and/or consequential damages for the breach of any express or implied warranty including damage to property and, to the extent permitted by law, damages for personal injury, even if VIC TOKAI INC. has been advised of the possibility of such damages. Some states do not allow the exclusion or limitation of incidental or consequential damages or limitations on how long an implied warranty lasts, so the above limitations or exclusions do not apply to you.

This warranty shall not be applicable to the extent that any provision of this warranty is prohibited by any federal, state or municipal law which cannot be pre-empted. This warranty gives you specific legal rights and you may also have other rights which vary from state to state.

# COMPLIANCE WITH FCC REGULATIONS

This equipment generates and uses radio frequency energy and if not installed and used properly, that is, in strict accordance with the manufacturers' instructions, may cause interference to radio and television reception. It has been type tested and found to comply with the limits for a Class B computing device in accordance with the specifications in Subpart J of Part 15 of FCC Rules, which are designed to provide reasonable protection against such interference in a residential installation. However, there is no guarantee that interference will not occur in a particular installation. If this equipment does cause interference to radio or television reception, which can be determined by turning the equipment off and on, the user is encouraged to try to correct the interference by one or more of the following measures:

- Reorient the receiving antenna
- Relocate the NES with respect to the receiver
- Move the NES away from the receiver
- Plug the NES into a different outlet so that computer and receiver are on different circuits.

If necessary, the user should consult the dealer or an experienced radio/television technician for additional suggestions. The user may find the following booklet prepared by the Federal Communication Commission helpful:

**How to Identify and Resolve Radio – TV Interference Problems.**

This booklet is available from the U.S. Government Printing Office, Washington, D.C. 20402, Stock No. 004-000-00345-4.

# VIC TOKAI INC.

TORRANCE TECH PARK  
370 Amapola Avenue, Suite 104  
Torrance, CALIFORNIA 90501

Printed in Japan